

## Wiring

Having correctly identified the wiring from your existing light fitting, pull the mains wire through the hole and connect to the connection block inside the product in the following way:

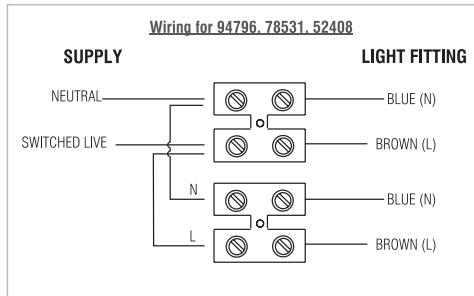

If there are any incoming earth cables, they must be joined together and well insulated with good quality insulation tape. This is to ensure earth continuity throughout your property.

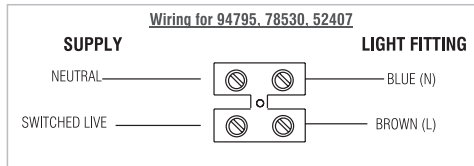
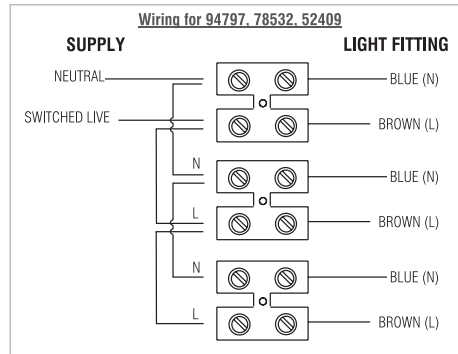

### Check that...

You have correctly identified the wires.  
The connections are tight.  
No loose strands have been left out of the connection block.

## Replacing bulbs



Unclip the front bezel and let the bulb drop out.  
Twist the pins into the lampholder, and twist back into the product.  
Clip the front bezel back in position.

## Technical data

Supply Voltage:	220-240 V~, 50 Hz	Bulb Type:	94795 / 78530 / 52407 : 1 x Max. 7W LED GU10 94796 / 78531 / 52408 : 2 x Max. 7W LED GU10 94797 / 78532 / 52409 : 3 x Max. 7W LED GU10
-----------------	-------------------	------------	--



Conformity with all relevant UKCA Directive requirements.



Conformity with all relevant CE Directive requirements.



The power supply is Double Insulated and does not require connection to an Earth circuit.



Waste electrical products should not be disposed of with household waste. Please recycle where facilities exist. Check with your Local Authority or local store for recycling advice.



This product is suitable for dimming.

## Care and Safety

We recommend cleaning with a soft dry cloth. Do not use solvents or abrasive cleaners as these could damage the finish.  
For your safety, always switch off the power supply before cleaning.  
Always disconnect the product from mains at least 10 minutes allowing to cool down before any maintenance or adjustment.

## Instruction manual

# Xeno Recessed

94795, 78530, 52407, 94796, 78531, 52408, 94797, 78532, 52409

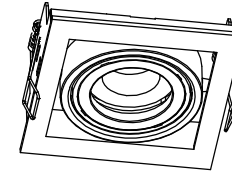

94795, 78530, 52407

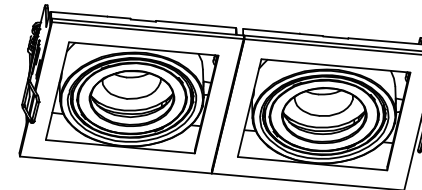

94796, 78531, 52408

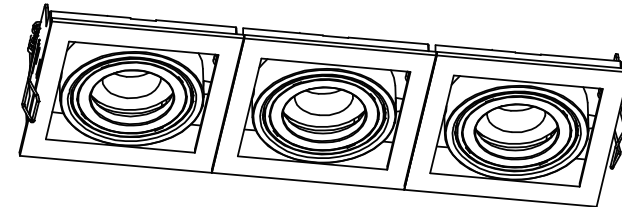

94797, 78532, 52409

Thank you for purchasing this light fitting. Please read the instruction carefully before use to ensure safe and satisfactory operation of this product. Please retain these instruction for future reference.

## Warning

 This light fitting is double insulated and does not require connection to an Earth circuit.

Please read these instructions carefully before commencing any work

This unit must be fitted by a competent and qualified electrician.

Install in accordance with the IEE Wiring regulations and current Building Regulations.

Check the pack and make sure you have all the parts listed.

To prevent electrocution switch off at the mains supply before installing or maintaining this fitting. Ensure other persons cannot restore the electrical supply without your knowledge.

This light fitting should be connected to a circuit.

If replacing an existing fitting, make a careful note of the connections

Always use the correct type and wattage bulb. Never exceed the wattage stated.

When changing a bulb, always switch off at the mains and allow the old bulb to cool down before handling.

Dispose of used bulbs carefully and responsibly.

This product is suitable for dimming when used in conjunction with a dimmable lamp. Always check dimming capability of the intended lamps.



This product is NOT suitable for direct mounting on normally flammable surfaces (suitable only for mounting on non-combustible surfaces).

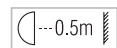

Spotlights give a concentrated beam of light and must not be positioned any closer than 0.5M (50cm) to the illuminated surface.

Waste electrical products should not be disposed of with household waste. Please recycle where facilities exist. Check with your local authority or retailer for recycling advice.

## Layout

Plan the desired layout of these fittings carefully, ensuring the cables will reach the distances between the junction box and the each light fitting.

Avoid locating any cables in positions that would cause a hazard. Position cables and junction boxes (not supplied) away from areas where they may be at risk from being cut, trapped or damaged.

The mains supply cable must have a minimum cross section area of 1.0mm<sup>2</sup>.

Cables must be protected using suitable conduit or plastic trunking.

The distance between units must be 0.5m minimum.

The unit must be located a minimum distance of 100mm from a joist.

This product must be mounted out of arms reach.

This product has no special protection against the ingress of moisture.

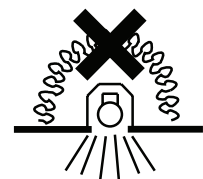

Ensure free movement of air around the fitting by removing any roof void insulation from at least 150mm around the hole. Under no circumstances must these fittings be covered with insulating matting or similar material.

## Installation

Existing fittings must be completely removed before installation of a new product. Before removing the existing fitting, carefully note the position of each set of wires.

Note that the switch is turned off before installation.

The ceiling surface must be flat and smooth to ensure a good fit.

- Cut the correct sizes hole according to your model of fitting using an appropriate tool (**See Fig 1**). It is recommended to cut the hole slightly smaller than needed, then file the hole until the recessed unit fits snugly.
- Ensure free movement of air by removing void insulation from at least 150mm from around the hole. Under no circumstances must these fittings be covered with insulating matting or similar material.
- Ensure that the void depth is a minimum of 150mm.
- Follow the installation steps below to install.
- Fit the spring clips to the product by squeezing together, and locating over the tabs. Ensure that the bracket with the terminal block is fitted as well.
- Adjust the tilt before switching on.
- Replace circuit breaker and switch on. Your light is now ready for use.

